

# **HP INTERFACE BUS DIGITAL TIMING FAMILY**

## **TRAINING MANUAL**

**59308A Timing Generator**  
**59309A Digital Clock**

HEWLETT  PACKARD

# TABLE OF CONTENTS

Section	Title	Page
1	INTRODUCTION .....	1
2	HP INTERFACE BUS DIGITAL TIMING FAMILY .....	2
	Time of Day Clock Features and Advantages .....	2
	Remote Update, Slaved Operation .....	2
	Easy Programming .....	2
	Data Logging Complete with Time Information .....	3
	Time on the Fly .....	3
	Clock Error Indications .....	3
	Clock Standby Power .....	3
	Crystal Timebase .....	4
	Clock Advantages for Calculator-Based Systems .....	4
	Clock Advantages for Computer-Based Systems .....	4
	Timing Generator Description and Advantages .....	4
	Summary: Comparison of Roles .....	5
	Timing Generator .....	5
	Time of Day Clock .....	5
	Both Clock and Generator .....	5
3	CONTROLLERLESS APPLICATIONS .....	6
	Application: Precision Sample Trigger .....	6
	Application: External Gate Drive for the 5345A Counter .....	7
	Application: Data Rate Controller for Counter-Printer Combination .....	7
	Application: Digital Divider .....	8
	Application: Digital Rep Rates for Pulse Generators and Shaped Pulses for the 59308A .....	9
4	SYSTEMS APPLICATIONS .....	11
	Application: Subsecond Timing .....	11
	Application: Programmable Delays for Instrument Settling .....	12
	Application: Instrument "Timed Out" Messages .....	13
	Application: Systems Pacing .....	13
	Application: Time Axis for a Plot .....	14
	Application: Plot with Time Notation .....	14
	Applications: Frequency/Time Measurements .....	14
	Application: Clock, Timing Generator, 5345A Counter Logging Data .....	15
5	UNDERSTANDING THE TIMING GENERATOR'S USE OF SRQ .....	19
6	SUMMARY-OPERATING THE 59308A TIMING GENERATOR .....	21
7	SUMMARY-OPERATING THE 59309A DIGITAL CLOCK .....	22

## LIST OF FIGURES

Figure	Title	Page
1	HP 59308A Timing Generator and HP 59309A Digital Clock .....	1
2	Block Diagram of Sample Trigger Pacing .....	6
3	Block Diagram of Gate Driver Setup .....	7
4	Paced Print Rate for a Counter-Printer .....	8
5	The 59308A Serving as a Digital Divider .....	9
6	Pulse Generator with Digitally Controlled Rep Rate .....	9
7	Block Diagram of Stepped Gate Through Waveform .....	10
8	Block Diagram of System to Make a Benchmark .....	11
9	Time Axis Plot .....	14
10	Demonstration of Clock and Timing Generator .....	15

## HOW TO USE THIS MANUAL

*To help you make effective use of this multipurpose document, here is a guide to its contents based on your interest. See the List of References for documents that are a pre-requisite to this manual.*

### FOR A GENERAL INTRODUCTION TO CLOCK AND GENERATOR:

Read Sections 1 and 2 and select among the applications in Section 3 those of interest.

### TO LEARN HOW TO PROGRAM AND OPERATE THE CLOCK:

#### 9820A/21A Calculator

1. Review Ref. 1 and 4.
2. Set up the clock and calculator, clock address P/0, (see Operating Summary, p. 21).
3. Enter and run Program A, page 16.

#### 9830A Calculator

1. Review Ref. 2 and 4.
2. Set up the clock and calculator, clock address P/0 (see Operating Summary, p. 21).
3. Enter and run Program A, page 17.

### TO LEARN HOW TO PROGRAM AND OPERATE THE TIMING GENERATOR, CLOCK, AND THE 5345A COUNTER:

#### 9820A/21A Calculator

1. Review Ref. 1, 3, 4, and 5.
2. Set up the generator, clock, counter, and calculator according to Figure 10.
3. Refer to Operating Summaries, p. 21 and 22.
4. Enter and run Program B, page 16. For the 9821A Calculator, "starred" statements are 9821A equivalents (gold key for Record key).

#### 9830A Calculator

1. Review Ref. 2, 3, 4, and 5.
2. Set up the generator, clock, counter, and 9830A according to Figure 10 (replacing the 9820A with the 9830A).
3. Refer to Operating Summaries, p. 21 and 22.
4. Enter and run the Program on page 18.

### FOR ADVANCED TIMING GENERATOR PROGRAMMING (SRQ):

#### 9820A/21A Calculator

1. Read Section 5 and its program. Try entering and running the program.

#### 9830A Calculator

1. Read Section 5. Try the Program on page 18; it uses SRQ.

### MINIMUM RECOMMENDED CALCULATOR/INTERFACE COMBINATIONS:

#### 9820A/21A Calculator

9820A/21A Opt. 001 (additional memory)  
59405A HP-IB I/O Opt. 20 (or Opt. 21)  
59308A Timing Generator  
59309A Digital Clock  
Cables 10631A, B, or C  
Recommended: Math ROM, Plotter ROM,  
9862A Plotter

#### 9830A Calculator

9830A Opt. 001 (additional memory)  
59405A HP-IB I/O Opt. 030  
Opt. 274 String Variables  
59308A Timing Generator  
59309A Digital Clock  
Cables 10631A, B, or C  
Recommended: Opt. 271 Plotter Control,  
9862A Plotter

### REFERENCES

1. Hewlett-Packard Interface Bus User's Guide (9820A/21A Calculator) Price, \$20
2. Hewlett-Packard Interface Bus User's Guide (9830A Calculator) Price, \$20
3. 59308A Operating Manual
4. 59309A Operating Manual
5. 5345A Operating Manual

# 1. INTRODUCTION

Most instrumentation systems work requires timing capability. Just a few of the ways time of day, time interval, and pacing are used in a measurement system are these: scheduling measurement sequences, logging data with calendar and time notation, measuring event times, executing program benchmarks, plotting events against a time axis, inserting known delays, and initiating measurements on a periodic basis, precisely paced.

This training manual introduces to you the new pacing/timing modules Hewlett-Packard now offers for extending instrument capabilities. Features and benefits of the 59308A Timing Generator and the 59309A Digital Clock are discussed briefly, followed by applications. A broad coverage is provided for applications, ranging from those where no controller is required to powerful yet simple systems built up with the Hewlett-Packard Interface Bus (HP-IB). Calculator software programs for the HP 9820A/21A and the HP 9830A Calculators are presented and discussed to serve as training exercises, as models, and as a resource for user programs.

This manual exists to provide technical information for Hewlett-Packard factory and field engineering teams around the world. Anyone who wishes to add pacing and timing to a set of instruments interconnected with the HP Interface Bus will find useful information here. The manual is organized to supplement technical data sheets and instrument operation and service manuals by providing expanded applications information and programming tips. You are referred to these necessary primary sources of information for details.

The digital clock and the timing generator are, we believe, two of the most versatile and generally useful instrumentation systems building blocks we have offered for use with the HP 9800 Series Calculators and major measuring instruments such as the HP 5345A Counter. We anticipate many unusual applications for them and invite the reader to drop us a note to share these with others or to ask questions.

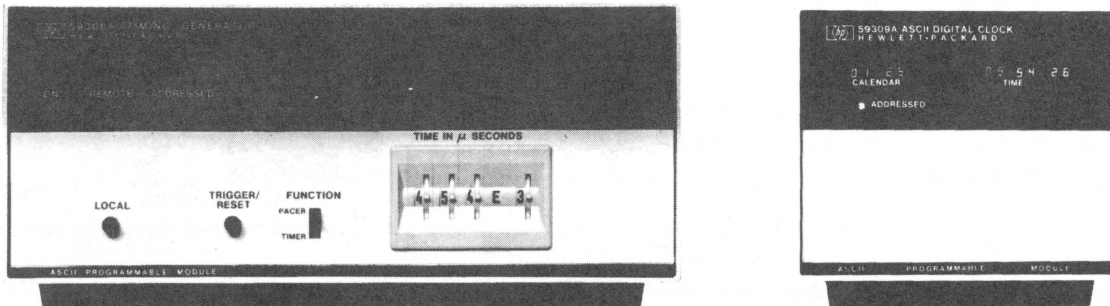

Figure 1. HP 59308A Timing Generator and HP 59309A Digital Clock

## 2. HP INTERFACE BUS DIGITAL TIMING FAMILY

To provide customers with the most cost effective match for their instrumentation timing needs, the Digital Timing Family is partitioned into three modular units: the clock, the timing generator, and clock standby power. Most customers will want the set: today's most compact and complete timing capability in one rack width only 3-1/2 inches high.

The clock provides time of day and the calendar: month, day, hour, minute, and second. As the months roll by, the calendar remains correct as long as the clock has power. A built-in computer knows how many days are in each month. Only once every 4 years does the calendar require operator intervention, to set the "leap year" switch. The clock outputs calendar and time onto the Interface Bus for any desired destination such as a data plot or printout. The clock also displays calendar and time on its LED (Light-Emitting-Diode) readout.

The timing generator supplements the clock by providing various functions other than time of day. The key to understanding the roles the clock and the generator play in system timing is this: the clock has one job, to report the calendar and time of day to the second on demand by operator or system. The timing generator provides the rest: subsecond timing down to the microsecond, time interval measurement, system pacing, and system scheduling.

The clock standby power module provides the means to maintain system time despite power outages. Simple flashlight size D-cells stacked into a module the same size as the clock can furnish up to a year's standby. Compare that to the standby battery packs clocks used to need — lead-acid batteries of the type used in automobiles are not uncommon.

To take care of uses that do not require long standby, a receptacle is provided in the clock itself for a 9V battery of the transistor radio type. Such a battery can overcome power glitches and give about a day's operation.

### TIME OF DAY CLOCK FEATURES AND ADVANTAGES

More is required of a clock that serves in a system. First of all, the need for operator intervention must be kept to a minimum. Every 4 years is tolerable! Second, the clock should go on ticking even during system shutdown. Third, error indications must be present if time has become uncertain. Fourth, the clock must be remotely programmable so that it can be commanded to output the time to a running program. All these the 59309A provides, and it goes further to give complete remote update and hardware time memory, as will be discussed.

#### Remote Update, Slaved Operation

Up to now, no system clock we know about could be started, stopped, reset, and updated remotely by simple commands made up of a few ASCII characters. And except for elaborate clock systems far more costly than the 59309A, none could provide additional time displays slaved to a system master clock. This slaved operation is possible with 59304A Numeric Displays on the Interface Bus.

#### Easy Programming

To make the programmer's job easier, the 59309A reports time in the format best suited to the task at hand. An internal switch the size of a digital IC lets you choose output to be the full calendar and time with the digit delimiters or not, or just time of day with calendar omitted.

Do you want a time printout in the customary notation with hour, minute, and second digits separated by colons? Or, do you want time with comma delimiters (separators) for program storage and manipulation? Or, digits without any delimiters to use as part of a computation? You can have what you want without the need to write elaborate bit-pushing subroutines to reformat your time values; just set the format switch and let the hardware do it. For example, digits output can be MM:DD:hh:mm:ss or just hhmss.

Commands to the clock are the ultimate in simplicity. You address the clock to listen on the Interface Bus and send ASCII character codes to set calendar and time values and to start and stop the

clock. For instance, suppose you want to correct the time for Daylight Savings by adding one hour. You can update the time register by register. To update the hours register, you simple send one letter "H" down the Bus. The number of times you repeat H denotes the number of counts needed to advance the display to the correct value.

An important advantage is that time is maintained by a running clock while the setting operation is being accomplished. Synchronization is not lost. Pulses being input to update the counting chains are accepted without interfering with pulses arriving for timekeeping purposes.

### **Data Logging Complete with Time Information**

The date and time a set of data points was taken or a printout was made is a vital part of the record for any collection worth keeping. With the 59309A in a system, the time can be recorded right along with the data. The calculator printer, the digital plotter, the numeric display, or any other calculator or computer peripheral device capable of reproducing numbers can log data complete with time entry.

### **Time On the Fly**

Time storage is provided in the clock to hold a reading for later output. It may be important to note the exact time at a definite point in a running program, say at the moment when a reading is taken. However, it may not be convenient or even possible to complete the actions of sending the time to the system controller for storage. This problem is solved with the 59309A Clock. The command "C" sent down the Bus results in having a time value stored in the clock's register. At a later point, when the clock is addressed to talk, the saved value is output. Meanwhile, the clock display is updated as usual. This "time on the fly" provision removes the need for the programmer to make timing trade-offs or accept estimates rather than actual time.

In an alternate operation, it is possible to have the clock record the time when a Bus command is sent to a group of instruments via "Group Execute Trigger." The clock's response to GET is to record the time in its save register for later output, as discussed in the last paragraph. The GET command can be used, for example, to trigger an instrument to take a reading and the clock to record the time, simultaneously.

### **Clock Error Indications**

For systems purposes, it's important to know when a time error could exist in reported time data. The 59309A Clock indicates possible error both visually and in the data string. Display decimal points all light and the status character "?" appears at the beginning of each output data string. These indications remain until the clock is reset.

Error indications are issued whenever time base counts are missed. This is a much more sensitive indicator than mere supply voltage drops would be and it provides a high degree of confidence in the time as reported by the 59309A.

### **Clock Standby Power**

To maintain time day after day is actually an impossible task if the system must rely on a wall plug. While ac power outages are unusual, they do occur. Then there's the problem of the pulled plug or the turned-off switch. An automatic system that depends on having the time maintained over months rather than days requires that the system clock be provided with standby power.

The 59309A can keep its timing chains going on as little current as 1.5 mA. The design was carefully optimized for low power drain by use of C-MOS and by having all non-vital functions discontinued during battery operation. The result is that ordinary D-cells last virtually the shelf life of the batteries.

Cutover to battery operation is automatic. The display goes dark, removing its comparatively heavy drain. If an external standby supply is connected, the display can be lighted momentarily for reading by pushing a button. This button is inoperative if only the 59309A's internal battery is the power source, since it cannot withstand this drain and last. The operator need not consider these matters. The design has taken care of them.

The small size of the K10-59992 Standby Power Supply makes it easy to include in any system. To reload a fresh supply of batteries does not require removing the box from a rack mounting. Batteries load from the front.

### **Crystal Timebase**

The 59309A timebase is a crystal-controlled oscillator. This room-temperature crystal with aging rate  $5 \times 10^{-6}$  parts/yr affords control entirely adequate for ordinary timekeeping. The 59309A accepts at a rear panel BNC a 1, 5, or 10 MHz input. Where the 59309A is to be incorporated in a system with the 5345A Counter, it makes sense to use its high stability precision timebase (10 MHz, aging rate  $5 \times 10^{-10}$ /day). If a cesium beam primary standard is available, use that!

### **Clock Advantages for Calculator-Based Systems**

All of the system advantages so far mentioned apply whether the 59309A is incorporated in a system built around the HP 9820A/21A/30A Desktop Calculators or around the HP 2100 Series Computers. Special advantages for calculator systems include these.

First and foremost, the 59309A is compact and convenient to use with a calculator. Few system clocks have a front panel readout. The bright display afforded by the 59309A is a real asset.

Second, the 59309A's internal storage register makes it possible to capture event times otherwise difficult to do with a calculator because operation times are slow relative to a computer. This temporary storage lets the calculator program proceed with the primary data-taking tasks and accept the time value later when there will be no interference.

Third, provision for standby power lets the clock continue operation while the calculator system is turned off, so that the clock will be on time when the system operation is resumed.

### **Clock Advantages for Computer-Based Systems**

The HP 59309A Clock is interfaced to the HP 2100 Series Computers by the HP 59310A Bus I/O Card. This is the card that interfaces the 5345A and 5340A Frequency Counters to the computer, and the clock can use the same card.

Many computer systems have a software clock that ticks, of course, only as long as the system is in operation. It is an advantage to have a hardware clock like the 59309A to which the system software clock can be referenced on startup or restart.

Computer systems are often set up to keep the calendar on the basis of day-of-year digits, 001 to 365 (or 366 for leap year). The 59309A Option 001 provides this notation to replace the month/day-of-month notation.

### **Timing Generator Description and Advantages**

The HP 59308A Timing Generator responds to trigger inputs with precision timed pulses (flags) to perform such systems services as counting off time intervals, pacing measurements, and inserting known delays.

Intervals from microseconds to days (001E0 to 999E8  $\mu$ s) can be set into thumbwheel switches or programmed. Either of two operating modes may be selected: pacer mode or timer mode.

In timer mode, an external start pulse, front panel pushbutton, or Bus trigger begins an interval of preset length which is counted off and terminated with an output pulse or Bus signal. The function performed is essentially that of a delay generator.

In pacer mode, pacing signals are output on a continuing basis. After an initial trigger signal is accepted to start off the sequence, pacing signals are output at the beginning of the first interval and at the end of each consecutive interval.

The 59308A interfaces with the outside world two ways, via the HP Interface Bus and via signal lines connected to rear panel BNC's. Trigger inputs to the 59308A and its timing/pacing signal responses are available both as coded messages on the Bus and as pulses. This design feature lets the 59308A serve a broad range of instrumentation pacer-timer needs. Further increasing its versatility, the 59308A is tolerant of signal duration and level. Separate BNC outputs provide TTL and ECL levels with switch-selection of square wave or pulse and of positive-going or negative-going edge. A BNC input accepts input triggering on either edge and a minimum acceptable level with either a 0.5V or a 2V threshold.

An internal 6-digit counter is incremented once per time interval and its totalized count is output when the 59308A is addressed to talk on the Bus. A typical use of this counter is to record an elapsed time between two program steps for benchmark purposes.

The 59308A has a 10 MHz crystal-controlled timebase and it also accepts an external timebase. Internal timebase aging rate is 3 parts in  $10^7$  per month.

Programmable functions include operating mode, interval length, and output format. Program commands are simple and easy to use. They are described on the Operating Summary page.

Applications for the timing generator range over an unusually wide territory. Since system advantages are best understood in terms of individual applications, their discussion is continued in the Applications Section.

## **SUMMARY: COMPARISON OF ROLES**

To further delineate the application areas served by the timing generator and the clock, major areas are summarized as follows.

### **Timing Generator**

Pacing periodic measurements.  
Establishing precise delays.  
Establish settling interval for device response to stimulus.  
Scheduling program execution where program is to be run periodically and the interval is the key.  
Two timing generators, one for scheduling, one for timing program events.

### **Time of Day Clock**

Logging time an event occurred or a measurement was made.  
Recording the time a program starts or stops.  
Scheduling program execution where start times are aperiodic and/or time of day is the key.

### **Both Clock and Generator**

Clock for logging time of day, generator for subsecond timing.  
Clock for logging time of day, generator for scheduling program runs.  
Situations where two system actions involving pacing/timing need to be performed at the same time.



### 3. CONTROLLERLESS APPLICATIONS

Many instrumentation applications of pacing/timing and calendar/time of day do not require a calculator or other controller. Where remote operation is not the goal and measured data is directly useful without computation, the 59308A and 59309A can operate stand-alone with other measuring instruments such as counters and printers. In some cases, the setup does not even require digital interconnection with the Interface Bus.

Each module has front panel controls and rear panel connectors to make this stand-alone operation possible. The 59308A can itself assume the role of a simple controller. The 59309A can be reset, updated, started, or stopped by easily accessible controls concealed beneath its front panel.

This section describes briefly a few typical applications. For convenience these are grouped as "controllerless". It will be apparent that all can be transformed into "systems" applications by addition of a controller and its program.

Operation without a controller requires that the 59308A "Bus Pacer" switch be set to ON, see the Operating Summary page. The front panel function switch selects pacer mode or timer mode. The thumbwheel switches select the pacing or timing interval. The trigger/reset pushbutton starts a sequence.

#### Application: Precision Sample Trigger

A frequency counter can be supplied sample triggers precisely spaced in time by a BNC cable connected to the 59308A. The operator pushes the 59308A's Reset pushbutton to initiate the sequence of counter measurements which then follow, spaced at  $\Delta t$   $\mu$ s set into the thumbwheel switches, where  $\Delta t = 001E0$  to  $999E8$   $\mu$ s.

Because the 59308A offers pulse output levels suitable for TTL, ECL, MECL, E<sup>2</sup>CL and 50 $\Omega$  work, just about any counter capable of being externally triggered can accept inputs from the 59308A. Figure 2 shows the connections and pertinent control settings.

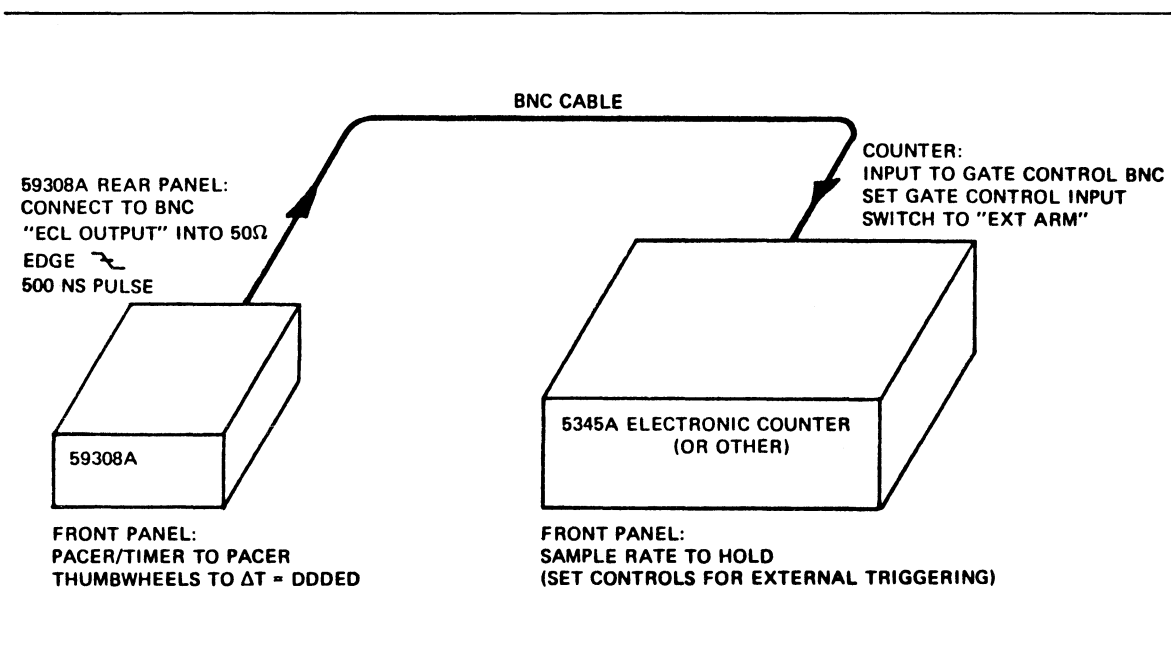

Figure 2. Block Diagram of Sample Trigger Pacing

### Application: External Gate Drive for the 5345A Counter

The 5345A Electronic Counter has switch-selected gate times over a wide range from 100 ns to 1000 sec in decade steps. For specialized measurements, external gating is accepted at a rear panel Gate Control Input with switch selection to EXT ARM or EXT GATE.

Selection of EXT GATE allows the operator to choose any arbitrary gate time longer than 50 ns by supplying a -1V level for the duration of the gate wanted. For example, selection of a gate just shorter than the width of an RF pulse would give maximum resolution for its frequency measurement.

The 59308A can provide a gate of arbitrary and precision length. Figure 3 shows the connections and the pertinent control settings. Gate time will be equal to one-half of the setting in the thumbwheel switches:

$$\text{Gate Time} = \Delta t / 2$$

Note: the exponent cannot be zero in square wave mode, that is, DDDE0 is not permitted.

The operator pushes the Reset pushbutton on the 59308A to initiate the sequence.

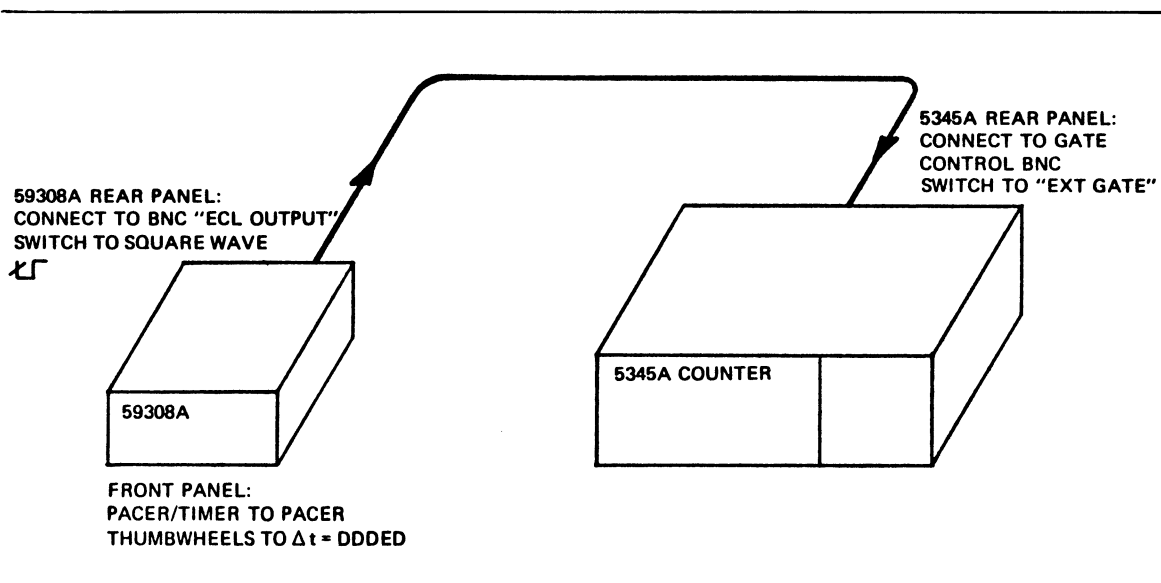

Figure 3. Block Diagram of Gate Driver Setup

### Application: Data Rate Controller for Counter-Printer Combination

The 59308A can act as a rate controller for a counter-printer combination, establishing a precise print rate each  $\Delta t$  seconds, where  $\Delta t$  is set into the thumbwheel switches.

Figure 4 shows the setup for using a Model 5050B (or 5055A) printer with the 5345A Electronic Counter. The 59301A ASCII-Parallel Converter is also needed, to translate the 5345A's ASCII-coded output into BCD for acceptance by the printer. The sequence of printout is started by pushing the 59308A Reset button.

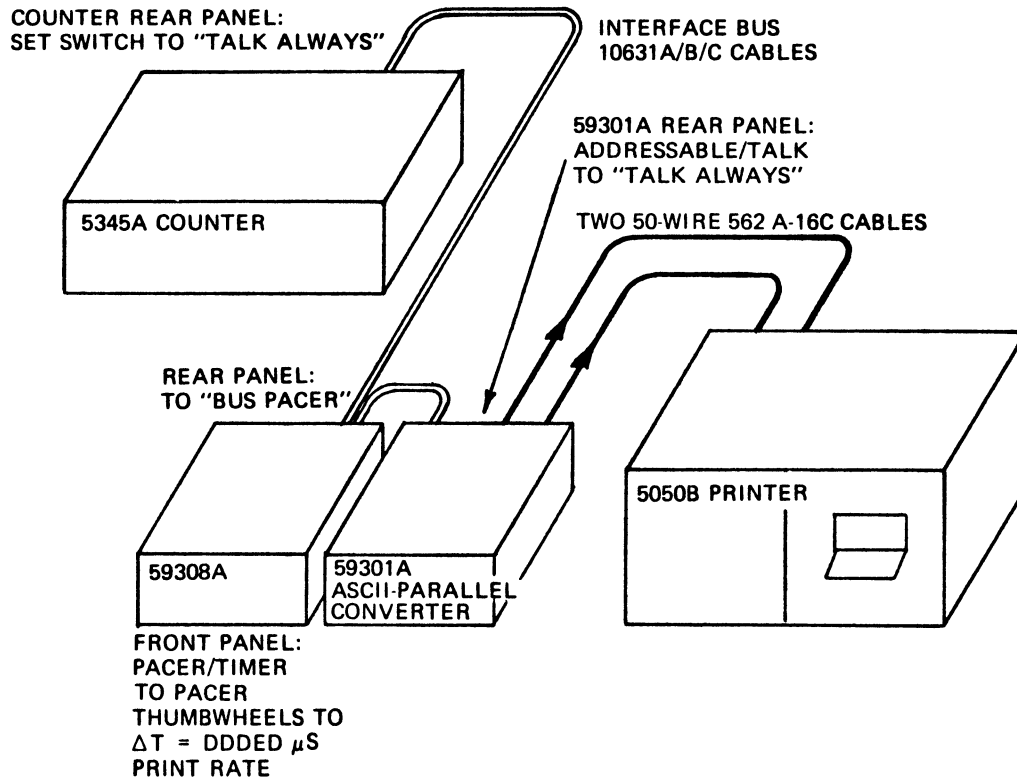

Figure 4. Paced Print Rate for a Counter-Printer

### Application: Digital Divider

The 59308A can perform as a digital divider capable of dividing not just in decade steps but by any selected number. The input is ac coupled. For sinewaves, the input frequency can range from 10 MHz to 1 kHz. For square waves (since the fast edge can couple through the capacitor), the input can be down virtually to dc.

Most counters have a rear panel output for the divided down frequency signal developed by the decade dividers. This has been found to be a useful capability. The 59308A extends this capability beyond what a counter can provide because it allows for division by any selected number, not just decade steps. This frequency division capability makes the 59308A a sort of synthesizer capable of producing any one desired frequency lower than the input.

Figure 5 shows the connections and suggests a use with an oscilloscope. The frequency displayed is given by:

$$f_{in} = \frac{f_{in}}{N}$$

Where:

$f_{in}$  = frequency input

N = integer DDDDED set into thumbwheels

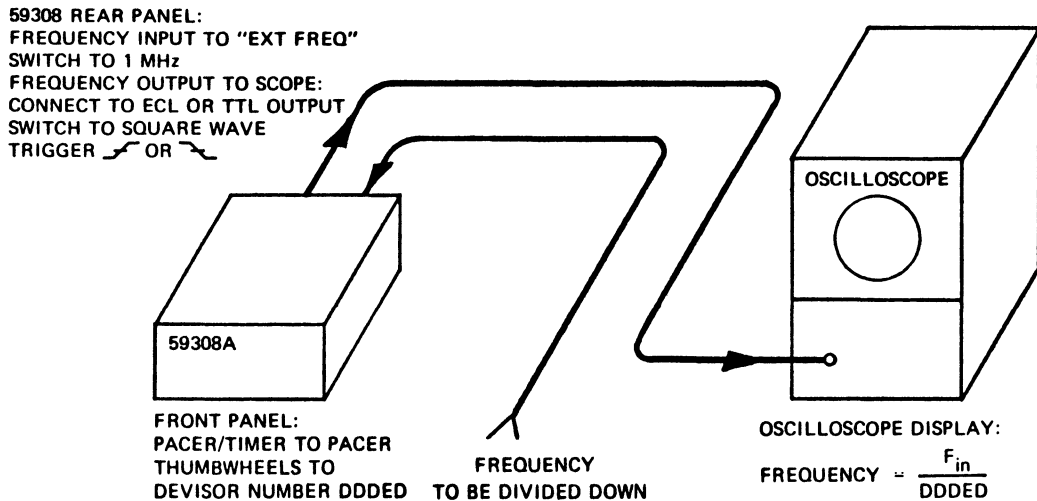

Figure 5. The 59308A serving as a digital divider

### Application: Digital Rep Rates for Pulse Generators and Shaped Pulses for the 59308A

Most pulse generators provide switch-selected rep rates, but periods rarely exceed milliseconds or seconds. The 59308A can be coupled with a pulse generator such as the Model 216A or 8013A to provide any arbitrary rep rate, even one having a period of more than a day. To look at this combination another way, the pulse generator supplies pulses "to order" with amplitude, width, rise and fall times specified by its own capabilities. The pulse shaping is a useful extension where the 59308A output of 500 ns pulses or square waves does not satisfy the requirements.

For instance, the 59308A and the HP 8013A Pulse Generator together form a multipurpose pulse source capable of generating a wide variety of output pulse waveforms either as single pulses or as pulse trains with precision rep rates established by the 59308A. Digital control of the rep rate means it is precise, is programmable (in a system), and can have the period set by thumbwheel switches at any number up to 999E8  $\mu$ s.

Figure 6 shows the setup for outputting pulses with period determined by the 59308A's thumbwheels. The 8013A is operated in Normal Mode with its rep rate generator externally triggered by the 59308A.

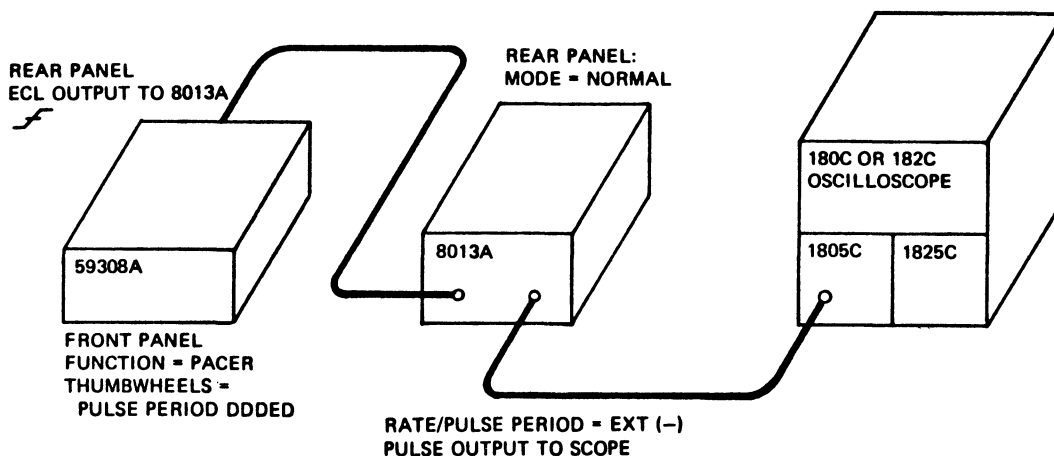
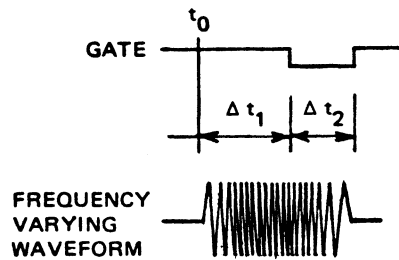

Figure 6. Pulse Generator with Digitally Controlled Rep Rate

An application for this digitally controlled pulse generator is to make it possible to step across a waveform to observe frequency variations within it. The 59308A determines the delay interval  $t_1$  and the pulse generator determines the gate interval  $t_2$ . The sketch shows these times.



A sync pulse derived from the waveform source at time  $t_0$  is sent to the 59308A and to the oscilloscope. The 5345A Electronic Counter is externally gated by the pulse generator to measure the frequency within the burst.

Figure 7 shows a block diagram to make it easy to set up a group of instruments for stepped measurements. The 59308A thumbwheel switches are reset to reposition the gated interval within the burst. The oscilloscope allows the operator to visually monitor the position.

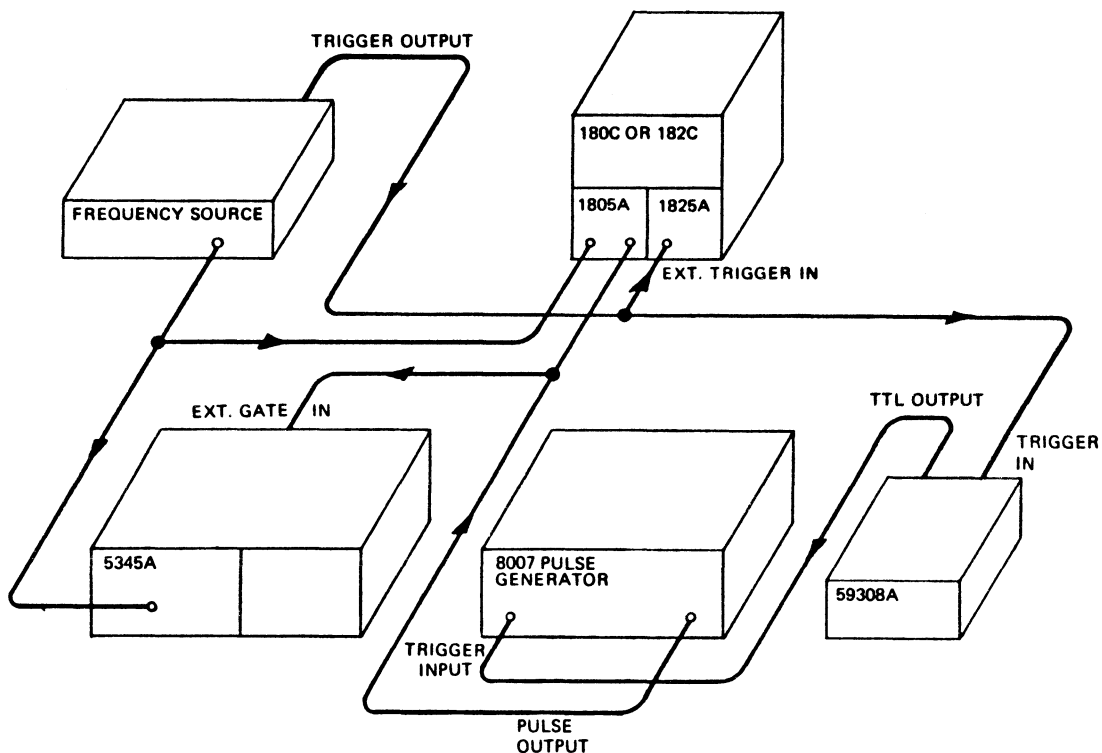

Figure 7. Block Diagram of stepped Gate through Waveform

## 4. SYSTEMS APPLICATIONS

This section discusses a few examples of the myriad of applications for the timing family in systems including HP desktop calculators (and minicomputers, for that matter).

Applications are discussed mostly with reference to the timing generator. The clock always performs the same all-important and well-defined function: keep and supply on demand the calendar and time of day. The two devices perform their tasks independently except where there is reason to relate them.

### Application: Subsecond Timing

This application uses the 59308A as a millisecond timer for developing a calculator program benchmark. Figure 8 shows a block diagram.

The measurement objective is to determine the time required for the 5345A Counter to make a typical frequency measurement. The elapsed time is to begin with the calculator's command to the counter to take a reading and is to terminate with the reading stored in a calculator register. The counter is assumed to have been programmed for a 10 ms gate.

The program overview follows. First, it is necessary to "calibrate" the timing generator/calculator combination. This is accomplished by addressing the generator to listen and triggering it (R) to begin counting. When it is addressed to talk, the value the generator reports is the time required to complete its action. This value is saved for later application as a correction.

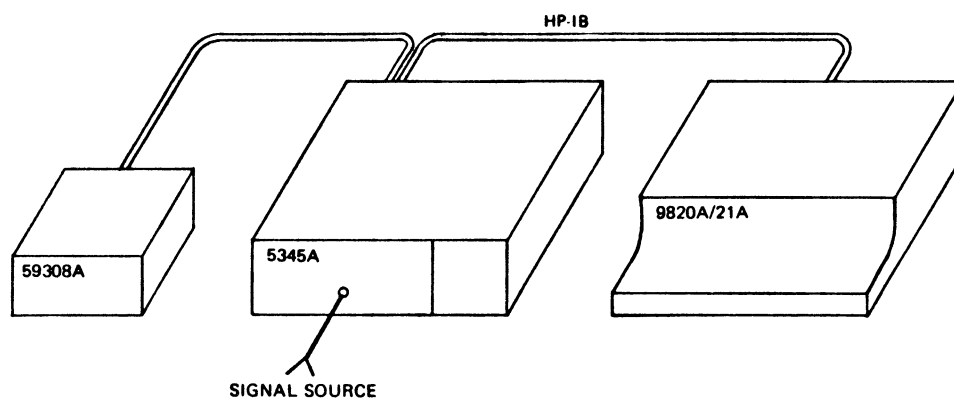

Figure 8. Block Diagram of System to Make a Benchmark

The generator is next sent a new trigger command (R) to reset and begin the actual time measurement and store it in a calculator register. The value the generator reports is the elapsed time required for the counter to make and return its measurement, for the calculator to operate, and for the pacer-timer to act. The final result is corrected by removing the pacer-timer "calibration" factor.

The 9820A Calculator program to make this measurement is reproduced from the printer tape along with one set of results. The 5345A's address is J/\*, and the 59308A's address is Q/1. A frequency of 5 MHz was measured with a 1 ms gate time.

The first result shows the benchmark took 40 ms to complete. As an exercise, the program was re-run with the 9820A operating in Trace Mode. With the calculator executing its program step-by-step, the measurement took 300 ms.

Most of the time actually was used by the calculator for transfer of commands and receipt of data. This could be confirmed by repeating the measurement with a long gate time. This example shows how the pacer-timer can be used to determine how long a certain program routine takes to run. It could be useful, for instance, to find out how long a delay will actually occur from the time an external instrument is commanded to make a measurement before the data point is taken.

Calculator program to measure a benchmark and the results.

```

0:
CMD "?U1","001E3
PR","?Q5";FMT #;
RED 13;CF
1:
CMD "?U*","12E89
G>"F
2:
CMD "?U1","R","?
U*","J1";CMD "?U
S";FMT #;RED 13;
RF
3:
CMD "?Q5";FMT #;
RED 13;BF
4:
FXD 4;PRT "TIME
IN MS=";B-CF
5:
FLT 6;PRT "F=";R
;SPC 2F
6:
END F
225262
R395

```

TIME IN MS= 40.0000  
F= 5.000910E 06

### Application: Programmable Delays for Instrument Settling

Operating in timer mode, the 59308A performs as if it were a precision delay generator to output one pulse when a preset interval has elapsed. This delayed pulse is useful to allow a measuring instrument to settle so that any transients have died away before it is triggered to acquire its measurement.

In a broader sense, settling time for stimulus-response measurements for a unit under test (UUT) has three components:

1. Time for the stimulus to reach final value.
2. Time for the UUT to respond to the stimulus.
3. Time for the measuring device to settle.

A programmable delay generator capable of being set for delays from microseconds to milliseconds on up is a very useful systems tool. With it, delays can be applied exactly as needed.

Systems using the HP 9820A/21A Calculator commonly employ programmed "time wasters" for settling delays. The disadvantage of this inelegant method is that times cannot be closely defined and valuable calculator cycles are wasted. The Display Statement is often used to insert delays; one execution consumes about 160 ms, not an ideal unit of time. While the 9830A is an improvement in that it has a Wait Statement, use of this statement still wastes cycles and times still cannot be closely defined.

The HP 59308A is easily programmed for the exact wait time desired. Examples of everyday instrumentation situations where this capability is handy include these: allowing the unit under test, relays, signal generators, and attenuators to settle.

When a step change is given to a signal generator, it takes a sensible time for the output frequency to become stabilized. Where a synthesizer lacks a "ready back" signal or it is inconvenient to use one, some external means of inserting a delay is a must. Relays and attenuators must be allowed to settle if signal bounce is a problem.

### **Application: Instrument "Timed Out" Messages**

Where a set of instruments is programmed to perform a series of interlocked sequences, it is advantageous to have an independent monitor to observe actions and direct responses accordingly. The 59308A performs as a monitor by watching the time a system action takes and developing "timed out" status messages for the controller. The controller can respond by directing the system down a branch path or alerting the operator. Examples of these applications will make them clear.

In the first example, a unit under test (UUT) is to have its output frequency measured in response to a stimulus. A microwave counter must lock to this output frequency in order to measure it. The system can be programmed to stimulate the UUT and to attempt for, say, 2.5 seconds to measure output frequency. If lock and measurement do not occur before the preset time expires, the 59308A presents its "timed out" signal which the controller can observe. The controller branches to a subroutine that makes some adjustment such as increasing the stimulus level and again tries the measurement.

In the second example, an operator's intervention is required to redirect the system. The 59308A can in effect develop a second status message and present it for the controller's action. Intervals can be timed as described in the last paragraph and a tally kept in the 59308A's interval counter. After, say, 6 intervals have passed and the measurement is not concluded successfully, the 59308A's tally can be read out and interpreted by the controller to call for a displayed message "Failed Lock" to alert the operator.

### **Application: Systems Pacing**

Pacing for the system as a whole is the province of the controller. Software directs operations such that, for instance, a data point has been taken and is stored before a subroutine which requires the data as input can begin execution.

Software pacing extends to specific tasks such as repeatedly triggering an instrument to rapidly acquire a sequence of measurements, which is a different time scale of pacing. Limitations do exist. Inconsistencies in instruction execution and maximum attainable speeds for I/O operations make it impractical to use a calculator for software pacing much below the 200 ms interval range.

The 59308A can help with overall systems pacing as discussed in other applications paragraphs. It really comes into its own for exact instrument pacing, filling the gaps left by software pacing and by built-in pacing such as instruments themselves sometimes have.

Take the case of a 3490A Digital Multimeter Option 030 (HP-IB Input-Output) and Option 040 (Sample and Hold). Sample/Hold provides the means to measure time varying voltages at one point in time. Operating in Track and Hold Mode, the 3490A can track a waveform and digitize it. When a hold command is issued, the input voltage is held and digitized. Tracking of the input signal then resumes. There are three basic ways to use Sample/Hold: 1) if the DVM has a high enough reading speed, entire low frequency waveforms can be digitized; 2) if the waveform is repetitive, a series of samples evenly offset in time can be taken on successive cycles, avoiding the need for such a high reading rate; and 3) synchronized sampling can be used to take readings at a specific point on a repetitive waveshape. All of these uses rely on precise pacing.



### Application: Time Axis for a Plot

The 59308A can be programmed to pace a series of measurements such that a plot of measured values vs time is produced by the HP 9820A/21A/30A Calculator and the 9862A Plotter. This plotting capability has a number of advantages not the least of which is that data can be taken at intervals spaced far enough apart in time to show long term trends and yet be fitted onto a simple plot.

The measurements can be precisely paced at exact intervals desired without regard to the usual limitation imposed by fixed sample rates, where instruments accept external trigger pulses.

An example of this capability to make a plot with time as the independent variable is contained in Application Note 174-11, "Measuring Warm-Up Characteristics and Aging Rates of Oscillators", discussed in the paragraph on Frequency/Time Measurements.

### Application: Plot with Time Notation

The 59309A Digital Clock outputs time on request of the system controller. It can be used with data logging devices to record time of day for data points. The plot of Figure 9 shows how the 59309A can output time to a plot being made with the 9820A/21A and the 9862A Calculator Plotter.

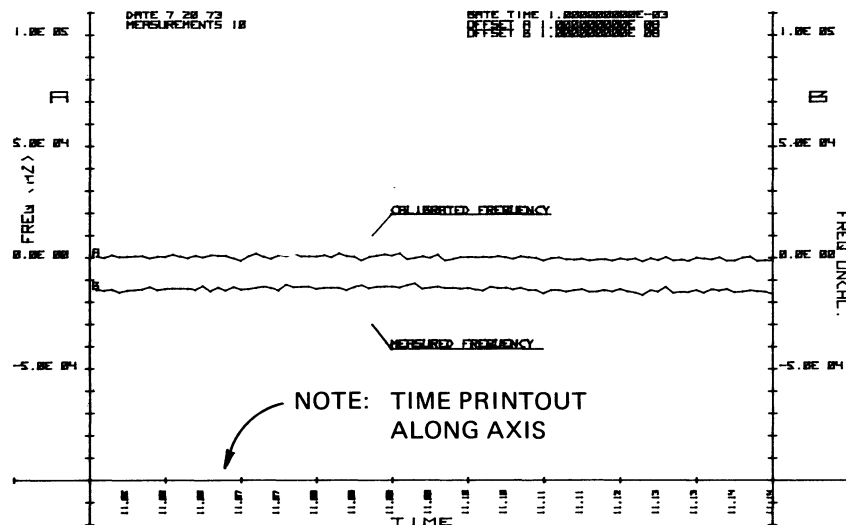

Figure 9. Time Axis Plot

### Applications: Frequency/Time Measurements

A series of Application Notes has been written describing state-of-the-art measurements made with the HP 5345A Electronic Counter and peripheral devices all under the control of the HP 9820A/21A/30A Calculator. Each note is complete in itself, providing a program listing, a block diagram, and technical notes on measurement capabilities. Three notes dealing with the HP 59308A Timing Generator are described here.

Application Note 174-11, "Measuring Warm-Up Characteristics and Aging Rates of Oscillators", uses the 5345A Counter, the 59308A, and the 9862A Plotter to measure and plot — automatically — the warm-up characteristic or aging rate of an oscillator. This system takes full advantage of the 59308A's programmable time intervals. The user simply keys in the answer to the question the program asks on the calculator's display, "Time (Sec)?" to specify exactly the interval time between measurements over a range from 5 sec to 99,900 sec. The number of measurements is also a user decision. The plot is automatically produced complete with its time axis in units of seconds.

Application Note 174-4, "Measuring Frequency Sweep Linearity of Sweep Generators", automatically plots the frequency vs time characteristic of the sweep generator under test. In addition, the program computes and plots the differential non-linearity curve. This system permits the user to specify the desired time interval, entered in response to the calculator's question, "Delta T?"

Application Note 174-12, "Measuring Frequency Sweep Linearity of Sweep Generators", automatically plots the frequency vs time characteristic of the sweep generator under test. In addition, the program computes the plots the differential non-linearity curve. This system permits the user to specify the desired time interval, entered in response to the calculator's question, "Delta T?".

Application Note 174-13, "Measuring the Tuning Step Transient Response of VCO's to 18 GHz", describes a way to automatically measure and plot a voltage controlled oscillator's response to a step in tuning voltage. The 59308A provides a timing range from 11  $\mu$ s to 99,900 sec with step sizes down to 1  $\mu$ s. A sampling technique similar to that of a sampling oscilloscope is used to capture the transient. Without the precise pacing capability of the 59308A, this measurement would not be possible.

### Application: Clock, Timing Generator, 5345A Counter Logging Data

This application uses the clock and timing generator working with the 5345A Electronic Counter in a calculator-based system logging data.

Two sets of calculator programs are provided, one to operate the HP 9820A/21A Calculator and one to operate the 9830A. Figure 10 shows a block diagram complete with addresses matching those used in the program listing.

Program A sets the clock automatically from values the user enters in answer to questions that appear on the calculator's display. Program B takes one frequency reading every 5 seconds and prints out the time as month, day, hour, minute, and second.

The 9830A programs include a commentary explaining instrument programming techniques useful to know for working with the clock and generator.

The clock setting routines can, of course, be used to operate the clock and calculator without the rest of the system. A good way to manage such a demo would be to first show how to set the clock manually, then show how to set it from the program.

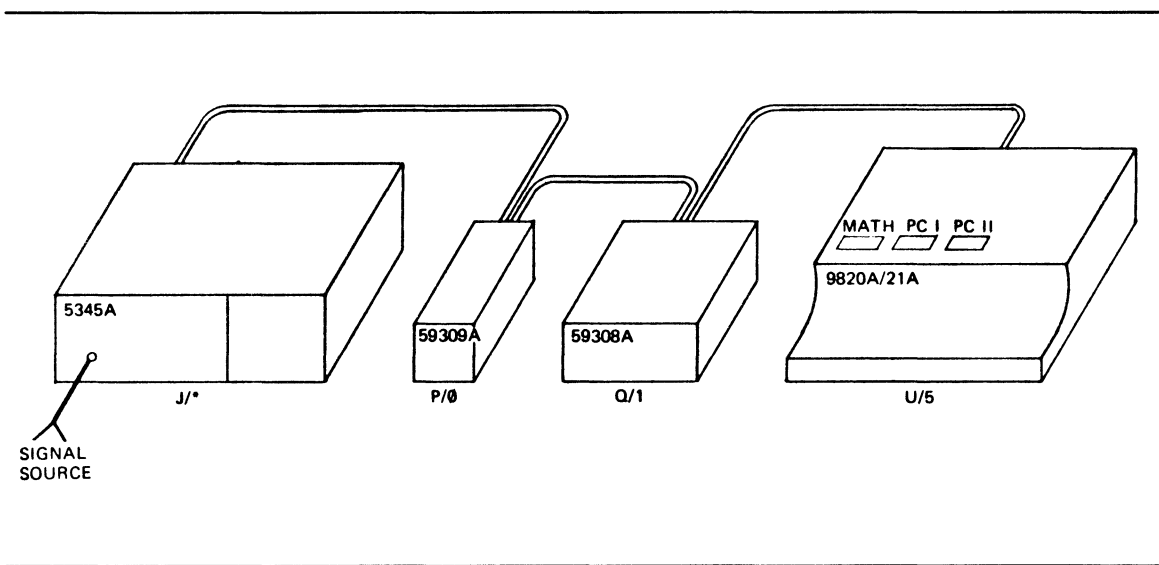

Figure 10. Demonstration of Clock and Timing Generator

Program A. Sets the 59309A calendar and time of day.

```

0:      DSP "SET THE CLO
1:      CK";DSP ;DSP ;
2:      DSP ;DSP F
3:      1:
4:      CMD "200", "PR";
5:      ENT "MONTH", AF
6:      2:
7:      JMP 13- AF
8:      3:
9:      CMD "200", "DDDDDD
10:     DDDDDDDDDDDDDDDDD
11:     DDDDDDDDDDDDDDDDD
12:     DDDDDDDDDDDDDDDDD" F
13:     4:
14:     CMD "200", "DDDDDD
15:     DDDDDDDDDDDDDDDDD
16:     DDDDDDDDDDDDDDDDD
17:     DDDDDDDDDDDDDDDDD" F
18:     5:
19:     CMD "200", "DDDDDD
20:     DDDDDDDDDDDDDDDDD
21:     DDDDDDDDDDDDDDDDD
22:     DDDDDDDDDDDDDDDDD" F
23:     6:
24:     CMD "200", "DDDDDD
25:     DDDDDDDDDDDDDDDDD
26:     DDDDDDDDDDDDDDDDD
27:     DDDDDDDDDDDDDDDDD" F
28:     7:
29:     CMD "200", "DDDDDD
30:     DDDDDDDDDDDDDDDDD
31:     DDDDDDDDDDDDDDDDD
32:     DDDDDDDDDDDDDDDDD" F
33:     8:
34:     CMD "200", "DDDDDD
35:     DDDDDDDDDDDDDDDDD
36:     DDDDDDDDDDDDDDDDD
37:     DDDDDDDDDDDDDDDDD" F
38:     9:
39:     CMD "200", "DDDDDD
40:     DDDDDDDDDDDDDDDDD
41:     DDDDDDDDDDDDDDDDD
42:     DDDDDDDDDDDDDDDDD" F
43:     10:
44:     CMD "200", "DDDDDD
45:     DDDDDDDDDDDDDDDDD
46:     DDDDDDDDDDDDDDDDD
47:     DDDDDDDDDDDDDDDDD" F
48:     11:
49:     CMD "200", "DDDDDD
50:     DDDDDDDDDDDDDDDDD
51:     DDDDDDDDDDDDDDDDD
52:     DDDDDDDDDDDDDDDDD" F
53:     12:
54:     CMD "200", "DDDDDD
55:     DDDDDDDDDDDDDDDDD
56:     DDDDDDDDDDDDDDDDD
57:     DDDDDDDDDDDDDDDDD" F
58:     13:
59:     CMD "200", "DDDDDD
60:     DDDDDDDDDDDDDDDDD
61:     DDDDDDDDDDDDDDDDD
62:     DDDDDDDDDDDDDDDDD" F
63:     14:
64:     CMD "200", "P";
65:     ENT "DAY", AF
66:     15:
67:     1+X F
68:     16:
69:     IF A=X; JMP 2F
70:     17:
71:     CMD "200", "D"; X+
72:     1+X; GTO -1F
73:     18:
74:     CMD "200", "P";
75:     ENT "HOUR", AF
76:     19:
77:     0+X F
78:     20:
79:     IF X=A; JMP 2F
80:     21:
81:     CMD "200", "H"; X+
82:     1+X; GTO -1F
83:     22:
84:     CMD "200", "P";
85:     ENT "MINUTE", A; 0
86:     +X F
87:     23:
88:     IF A=X; JMP 2F
89:     24:
90:     CMD "200", "M"; X+
91:     1+X; GTO -1F
92:     25:
93:     CMD "200", "P";
94:     ENT "SECONDS", A;
95:     0+X F
96:     26:
97:     IF X=A; JMP 2F
98:     27:
99:     CMD "200", "S"; X+
100:    1+X; GTO -1F
101:    28:
102:    DSP "RUN TO STAR
103:    T"; STP F
104:    29:
105:    CMD "200", "T" F
106:    30:
107:    END F
108:    R319

```

Program B. Paces frequency measurements with the 59308A and prints the calendar, time of day, and frequency.

9820A Version	9821A Version
0:	0:
1+ B; 10+ X F	1+ B; 10+ X F
1:	1:
CMD "20*", "I2E8E	CMD "20*", "I2E8E
9G> " F	9G> " F
2:	2:
CMD "201", "005E6	CMD "201", "005E6
PSR" F	PSR" F
3:	3:
IF RDS 13> 1.9;	IF RDS 13> 1.9;
JMP 0F	JMP 0F
4:	4:
** CMD "5025"; RDB 1	CMD "5025"; RDB 1
** 3+ Z; CMD "X" F	3+ Z; CMD "X" F
5:	5:
CMD "20*", "J1", "	CMD "20*", "J1", "
2J5"; FMT *; RED 1	2J5"; FMT *; RED 1
3; RBF	3; RBF
6:	6:
CMD "200"; FMT	CMD "200"; FMT
FLT 12.6; WRT 13;	FLT 12.6; WRT 13;
RB; CMD "2P5";	RB; CMD "2P5";
FMT *; RED 13; R11	FMT *; RED 13; R11
; R12; R13; R14; R15	; R12; R13; R14; R15
F	F
7:	7:
FLT 6; PRT "FREQ	FLT 6; PRT "FREQ="
" ="; RBF	" ="; RBF
8:	8:
FXD 0; PRT "H="; R	FXD 0; PRT "H="; R
11; PRT "D="; R12;	11; PRT "D="; R12;
PRT "H="; R13;	PRT "H="; R13;
PRT "M="; R14;	PRT "M="; R14;
PRT "S="; R15 F	PRT "S="; R15 F
9:	9:
SPC 3F	SPC 3F
10:	10:
B+ 1+ B; IF B< X;	B+ 1+ B; IF B< X;
GTO -6F	GTO -6F
11:	11:
SPC 8F	SPC 8F
12:	12:
CMD "20*", "I2" F	CMD "20*", "I2" F
13:	13:
END F	END F
R383	R383
	R377

Sample of Printout

```

FREQ =
      5.174005E 06
H=
      6
D=
      12
H=
      15
H=
      30
S=
      15

```

\*\*The first chinese character is Serial Poll Enable (push RECORD); the second is Serial Poll Disable (push JUMP). For the 9821A, these are respectively, push GOLD KEY; push JUMP.

## Program A. Sets the 59309A Clock from the 9830A Keyboard

```

10 REN
20 REN DEMO PROGRAM TO SET 59309A CLOCK FROM 9830A KEYBOARD.
30 REN 59309A ADDRESS=P70. MODE SWITCH = ADDRESSABLE.
40 REN MAKE SURE RUN/HOLD SWITCH IS AT RUN AND INT-EXT AT INT.
50 REN THE PROGRAM ASKS FOR DATE/TIME INFORMATION AND PROVIDES INSTRUCTIONS.
60 REN*****
70 DIM A(20),A(1),I(2),B(120)
80 DISP "WANT INSTRUCTIONS? (YES OR NO)";
90 INPUT A#
100 IF A#="YES" THEN 650
110 FOR N=1 TO 12
120 READ A(1),N)
130 NEXT N
140 DATA 0,30,59,90,120,151,181,210,240,270,304,334
150 DISP "KEY IN DIGITS/PUSH EXECUTE"
160 WAIT 2000
170 DISP "MONTH?";
180 INPUT M
190 IF M>12 THEN 330
200 DISP "DAY?";
210 INPUT D
220 IF D>31 THEN 330
230 DISP "HOUR?";
240 INPUT H
250 IF H>23 THEN 330
260 DISP "MINUTE?";
270 INPUT M
280 IF M>60 THEN 330
290 DISP "SECOND?";
300 INPUT S
310 IF S>60 THEN 330
320 GOTO 360
330 DISP "INPUT ERROR! TRY AGAIN"
340 WAIT 2000
350 GOTO 150
360 D=D+A(1),N)-1
370 CMD "200", "P"
380 FOR I=1 TO INT(D/24)
390 CMD "200", "00000000000000000000"
400 NEXT I
410 FOR I=1 TO 20*(D/24-INT(D/24))
420 CMD "200", "D"
430 NEXT I
440 IF H=0 THEN 460
450 FOR I=1 TO H
460 CMD "200", "H"
470 NEXT I
480 IF M=0 THEN 500
490 FOR I=1 TO M
500 CMD "200", "M"
510 NEXT I
520 IF S=0 THEN 540
530 FOR I=1 TO S
540 CMD "200", "S"
550 NEXT I
560 DISP "START CLOCK? (YES OR NO)";
570 INPUT B#
580 IF B#="YES" THEN 630
590 DISP "HOLDING/PRESS CONT. EXECUTE"
600 STOP
610 GOTO 560
620 CMD "200", "T"
630 CMD "Q"
640 GOTO 720
650 PRINT "INSTRUCTIONS TO SET CALENDAR AND 24 HOUR CLOCK (1100 PM TO 10 HOURS)"
660 PRINT "WHEN DISPLAY ASKS FOR MONTH= KEY IN DIGIT, CANCEL AND PRESS EXECUTE"
670 PRINT "CONTINUE ENTERING WITH DAY, HOUR, MINUTE, SECOND USE ONLY"
680 PRINT "TWO DIGITS PER ENTRY. PUSHER 'START CLOCK' BY LEVING IN '200'"
690 PRINT "CLOCK STARTS WHEN YOU PUSH EXECUTE."
700 PRINT
710 GOTO 110
720 END

```

### Commentary on Program to Set 59309A Clock from 9830A Keyboard

This program provides a really convenient way to set the calendar and time values into the 59309A Digital Clock. The complete program could be stored as a key on the 9830A labelled "Set Clock" for use when needed.

- 80 Written instructions that need be listed only if desired overcome tedious printouts and help insure that the novice operator correctly enters values for a successful demo.
- 110-140 To increment through the days of the year, it is necessary to have a record of cumulative days each month.
- 150-350 Input statements wait for the operator to key in the digits responding to "month?", etc. Note that each entry is checked. Operators often make mistakes!
- 360 The cumulative count of days is totaled. Since the 59309A resets to "01 01 00 00 00", an adjustment is made.

- 380-400 To provide speedy resets, the clock is presented a long string of "D" instructions to update the days (which cause the months to increment). The corresponding number of days is subtracted from the total in the variable D to keep the final value correct.
- 410-550 Days, hours, minutes, seconds are incremented to the values which the operator input earlier.
- 560-630 The operator is asked to start the clock so that if desired, the clock can be "synchronized" with another clock. To do so, a "seconds" value sometime in the future is input; when the reference clock reaches this value, the operator pushes "Execute" and the 59309A starts. If the operator wishes to wait awhile before starting the clock, he can answer "No" to the question "START CLOCK?". The program holds, but returns the operator to the question until the answer is "Yes" and the clock is started. This insures that the clock receives its "T" command to countermand the earlier "Q" command to stop. A clock left with the software command "Q" in effect cannot be started manually except by interrupting power to restore the "power up" conditions.

Program B. Paces Frequency Measurements with the 59308A and prints calendar, time and frequency.

```

00 REM FILE 11
00 REM
00 REM PROGRAM TO SEND 59308A/59309A/5345A MEASURING FREQUENCY AT
00 REM INTERVALS Paced BY THE 59308A AND LOGGING FREQUENCY AND TIME.
00 REM ADDRESSES ARE: 9830A=U/S, 5345A=J/*;59308A=Q/I, 59309A=P/O.
00 REM SET 59309A FORMAT SWITCH 1=CONNA,2=CAL,3=SPACE
00 REM MAKE SURE ALL MODE SWITCHES ARE SET TO 'ADDRESSABLE', NOT 'TALK ALWAYS'
00 REM PROGRAM USES STRING VARIABLE TO STORE TIME VALUE
00 REM *****JGE 8-26-74*****
00 REM
10 DIM A(20),T$(50),Q$(50)
20 CMD "9U*", "I2E89G)I1", "201", "003E6P5R"
30 FORMAT 10B
40 FOR I=1 TO 11
50 IF STAT13 <= 1,9 THEN 180
60 DISP "WAITING FOR SRQ:PASS NUMBER ="I
70 GOTO 150
80 OUTPUT (13,130)256,81,63,50,24,512)
90 IF RBYTE13=64 THEN 210
100 GOTO 150
110 OUTPUT (13,130)256,25,512)
120 CMD "9U*", "J1", "9J5"
130 ENTER (13,*A)I1
140 NEXT I
150 CMD "9P5"
160 ENTER (13,*T)
170 IF T$(1,1)="#" THEN 470
180 Q$(1,2)=T$(3,4)
190 Q$(3,3)="/"
200 Q$(4,5)=T$(6,7)
210 Q$(6,8)="/"74"
220 Q$(9,20)=""
230 Q$(21,22)=T$(19,10)
240 Q$(23,23)=""
250 Q$(24,25)=T$(12,13)
260 Q$(26,26)=""
270 Q$(27,28)=T$(15,16)
280 PRINT "CALENDAR"
290 PRINT Q$
300 PRINT
310 PRINT "FREQUENCY READINGS HZ"
320 FOR I=2 TO 11
330 PRINT A(I)
340 NEXT I
350 PRINT
360 GOTO 490
370 PRINT "TIME ERROR"
380 GOTO 410
390 CMD "9U*", "I2"
400 END

```

Flow Chart of program for 59308A, 59309A, and 5345A

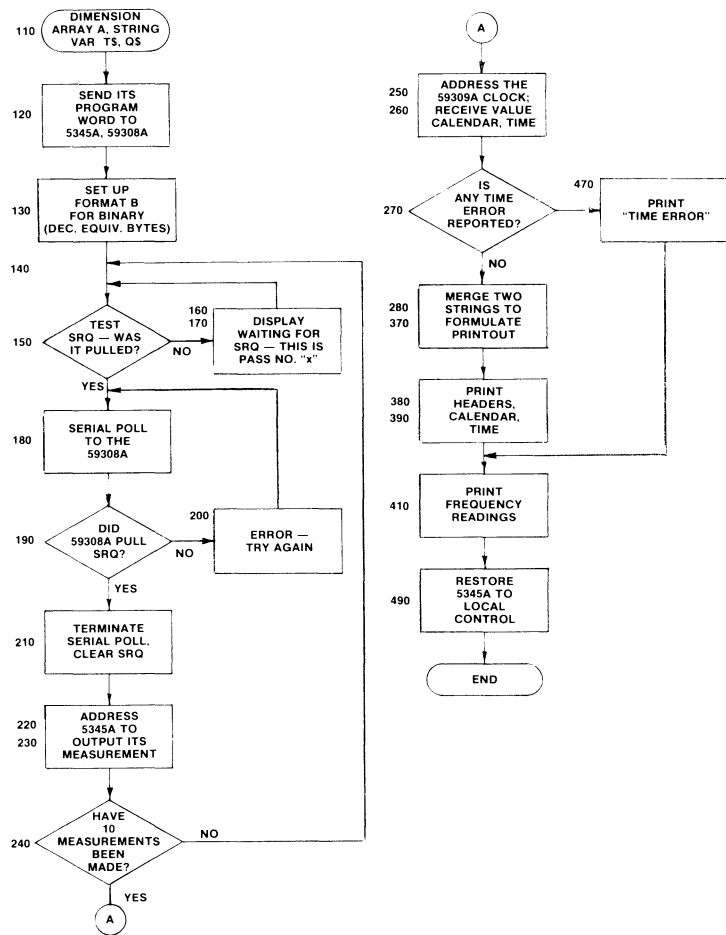

Typical Printout

```

CALENDAR          TIME
09/30/74         13:47:01

FREQUENCY READINGS HZ
62647200
62647200
62647220
62647160
62647370
62647300
62647210
62647200
62647130
62647220

```

Commentary on Program 59308A/59309A/5345A

- 120 Program word to 5345A: I2 = initialize, E8 = switch to remote control, E9 = hold for later-trigger, G = 10 ms gate, I1 = reset. Program word to 59308A: 003E6 = 3 sec time interval, P = pacer mode, S = enable SRQ (service request), R = reset.
- 150 "STAT 12" returns a status word that is 0 or 1 if SRQ has been made active to indicate one or more devices have requested service.
- 180 The OUTPUT statement serial polls to the 59308A. Decimal equivalents have these meanings.
  - 256 = ATN True (Low), places the HP-IB in the "Command Mode
  - 81 = Q, the talk address of the 59308A
  - 63 = ? the unlisten command
  - 53 = 5, the listen address of the 9830A
  - 24 = SPE, enables serial polling
  - 512 = ATN False (High), places the HP-IB in the Data Mode
- 190 If the 59308A has requested service it responds to its, talk address with "@" , for which decimal equivalent = 64.
- 210 The 9830A clears serial polling and SRQ. Decimal equivalents.:
  - 256 = ATN True, places the HP-IB in the "Command Mode
  - 25 = SPD, disables serial polling
  - 512 = ATN False, places the HP-IB in the Data Mode
- 220 The "J1" code triggers the 5345A to make its measurement. It then is addressed as a talker to send the value to the 9830A.
- 270 The 59309A outputs a "?" at the head of its data string if any timebase counts have been missed, indicating a possible error in the time reading.
- 280-370 The substrings T\$ contain the digits for month, day, hour, minute, and second. These are merged with string Q\$ to insert colons and slash marks.

## 5. UNDERSTANDING THE TIMING GENERATOR'S USE OF SRQ

The 59308A incorporates two powerful HP Interface Bus capabilities, Service Request and Serial Poll. You may not yet be familiar with these capabilities since they represent a level of sophistication beyond that required for simplest bus operation. The 59308A uses service requesting (SRQ) to ask for the calculator's attention. The calculator uses serial polling to identify the source of the service request. Multiple devices may be requesting service at the same time. The calculator polls to determine if a device has pulled SRQ and if so, why; then it clears that device's request so that others may be dealt with. The combination of requesting and polling is an additional way that a controller and devices interconnected in a bus system can communicate. Greater flexibility is imparted to system operation by making it possible for the instrument to indicate, say, that a measurement has been completed. The controller then can determine status (is it ready to output?) and can accept output at a convenient time.

"Demo SRQ" will help you understand service requesting and polling by illustrating operation with and without their use. The complete program listing, flowcharts, and explanations on a line-by-line basis follow. The Demo is meant as a self-teaching aid to understanding the 59308A.

The equipment required is the 59308A set to the address Q/1 to conform to the listing, the calculator equipped with the bus interface, and a cable (10631A/B/C) interconnecting the two.

The program is in two parts. Part 1 uses SRQ to let the 59308A indicate the end of its interval and uses serial polling to let the calculator identify the 59308A as the source of the service request. (Actually, serial polling is unnecessary since only the 59308A could be the SRQ source. Were any other device that uses SRQ — such as the 5345A Counter — also in the system, then polling would be required; it is included here for completeness.) Part 2 does not use SRQ. Both parts produce as the program output the contents of the 59308A's internal register. As explained earlier, the 59308A in pacer mode increments an internal register one count every time the selected time interval has elapsed, following the initial trigger. To read the contents of this register and learn how many intervals have passed since the trigger, it is necessary simply to address the 59308A to talk; to accept the value into a calculator register; and to output the value for observation on, say, a display or printer.

59308A Program "Demo SRQ"

Flowchart

```

0:
DSP "59308A DEMO
":DSP :DSR :DSP
: DSP F
1:
0+XF
2:
CMD "?U1","001E6
PSR"F
3:
IF RDS 13<1.9;
GTO 5F
4:
DSP "WAITING";
GTO 3F
5:
CMD "?+5*";CMD "
0":RDB 13+CF
6:
IF C=64;PRT "IT
IS I";GTO 8F
7:
PRT "NOT I";STP
F
8:
CMD "?+2":X+1+X;
IF X<5;GTO 3F
9:
CMD "?Q5";FMT *;
RED 13;A:FND 0;
PRT "INT REGISTE
R=";A;SPC 2F
10:
STP :0+B+XF
11:
DSP F
12:
CMD "?U1","001E3
PDR"F
13:
CMD "?Q5";FMT *;
RED 13;B;F
14:
FXD 0;DSP B;DSP
: DSP :DSP :DSP :
DSP F
15:
X+1+X;IF X<20;
GTO 13F
16:
FXD 0;PRT "INT R
EGISTER=";B;DSP
B;F
17:
END F
223827
R373
    
```

Typical Program Printout

```

IT IS I
IT IS I
IT IS I
IT IS I
IT IS I
IT IS I
INT REGISTER=
6
INT REGISTER=
22199
    
```

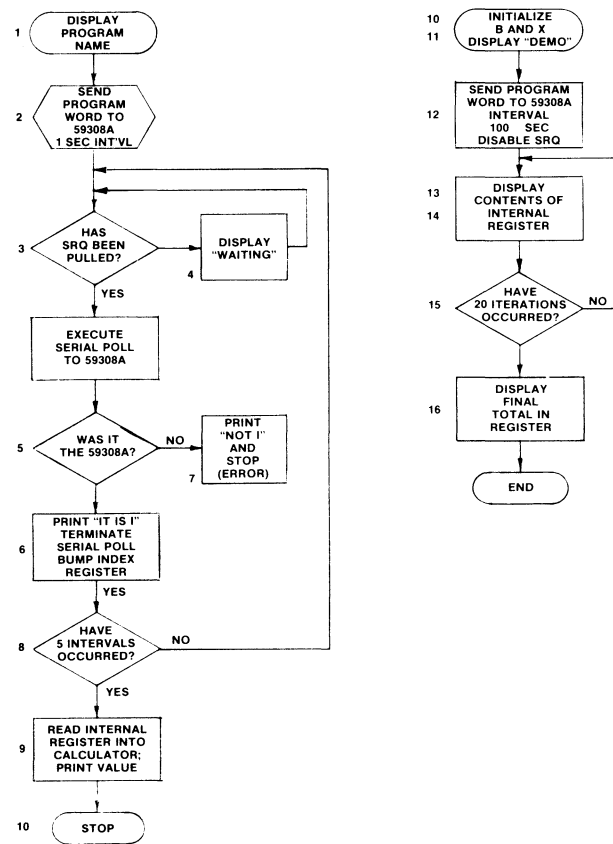

Demo SRQ — Program Explanation

Part 1

- 0: Display "59308A Demo SRQ" and hold it long enough to be read.
- 1: Initialize the X-register for later use as an index.
- 2: Send the 59308A its program word to set it up for 1-second intervals (001E6), enable pacer mode (P), enable SRQ (S), and reset and trigger it (R).
- 3: Test status; if SRQ has been pulled, either a 0 or 1 is returned and the program branches to statement 5; if not, continue.
- 4: Display "Waiting" to indicate SRQ has not been pulled (which in this case means the 59308A's 1-second interval has not elapsed) and again test status.
- 5: Issue a bus command (CMD) and serial poll: clear listeners (?), clear talkers (—), address the calculator as the listener (5), enable serial poll (diamond symbol, the gold key). (Note: the 9820A uses the Record key.) Address the 59308A as the talker (CMD "R"), which in this context causes it to output a status byte (64, the decimal equivalent of @). Accept status byte with a read byte into the C register.
- 6: Test the C register; if it contains 64, the 59308A has replied by answering the poll. If not, C contains NUL. Branch to statement 8.
- 7: Error message and halt. No other device could have pulled SRQ. Note that if, say, a 5345A were in the system, the poll could be

- 8: resumed to discover whether the 59308A were the device pulling SRQ.
- 8: Terminate serial polling by clearing listeners, clearing talkers, and sending serial poll disable (summation symbol, the Jump key). Increment the index register and test to see whether the program has looped for five times; if not, go back and again test SRQ to watch for the second interval to be concluded, etc.
- 9: Once the program has looped five times, proceed to print the final contents of the internal counter (Int Ctr = XXX). In an actual operation, this value could represent, say, the time in seconds for a given number of measurements to be completed. In this example program, the value will be the number of intervals, around 5 or 6 seconds.
- 10: Stop to indicate the end of Part 1. [To continue, press "Run Program" key.] Initialize the X-register for use as an accumulator.

Part 2

- 11: Display message letting operator know where program stands.
- 12: Send the 59308A a program word that establishes a 100 micro-second time interval (001E2), enables pacer mode (P), disables SRQ (D), resets and triggers (R).
- 13 to 17: Loop, display the contents of the internal register. Note that exact contents depend on the calculator in which the program is run; this time may vary slightly from one machine to another. Print the contents. The number presens the total number of intervals of 100 microseconds.

## 6. SUMMARY-OPERATING THE 59308A TIMING GENERATOR

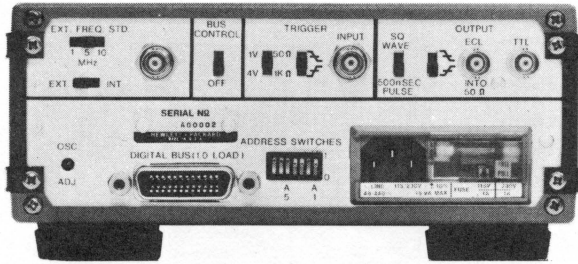

### 59308A REAR PANEL

#### External Frequency Standard Block

With Ext/Int switch set to Ext, BNC accepts 1, 5, 10 MHz (switch-selected) signal to replace the internal 10 MHz timebase.

#### Bus Pacer Block

Switch to Off for systems that include a controller.

#### Trigger Block

BNC accepts input; two switches select triggering on positive-going or negative going edge and minimum acceptable level, a 0.5V or 2V threshold.

#### Output Block

Separate BNC's output TTL and ECL levels with switch selection of square wave or pulse and of positive-going or negative-going edge. Set to Square Wave, provides a 50% duty cycle square wave with a period equal to interval selected on the thumbwheels (or programmed). Set to Pulse, provides 500 ns pulse at same intervals.

#### Lower Block

Osc Adj allows access for adjusting the internal oscillator (time base).

**Digital Bus Connector:** 24 pin connector (12151-3283; Amphenol 57-2-240-2) mates with cable (HP 10631A/B/C).

**Address Switch Assembly:** Switches A<sub>1</sub> thru A<sub>5</sub> select the address codes for the 59308A.

**AC Power Module:** I.E.C. approved connector, a fuse, and a 115/230 line voltage switch.

### 59308A FRONT PANEL

**On Indicator:** Light means the 59308A is powered.

**Remote Indicator:** Light means the 59308A is under remote operation and all front panel controls are inoperative (except see Local pushbutton).

**Addressed Indicator:** Light means the 59308A is addressed to talk or to listen.

**Local Pushbutton:** When pushed, returns the 59308A to front panel control unless "local lockout" command has been sent.

**Trigger/Reset Pushbutton:** When pushed, starts timing generator output and resets the output counter to zero; trigger occurs when the button is released.

**Function Switch:** Set to Pacer, the 59308A outputs signals (flags and pulses) on and after each consecutive interval following the start trigger. Set to Timer, the 59308A outputs one signal (flag and pulse) following the start trigger.

**Thumbwheel Switches:** Select time interval in microseconds. Range, 001E0 to 999E8  $\mu$ s.

Example Interval Settings\*

Time Interval	Thumbwheel Setting
1 $\mu$ s	001E0
100 $\mu$ s	100E0
1 ms	001E3
100 ms	100E3
1 sec	001E6
100 sec	100E6
1 min	060E6
1 hour	036E8
1 day	864E8

\*Square wave setting cannot be used if the exponent is 0.

### GENERAL

#### Output Pulses

Rise Time, 50 ns; Fall Time, 50 ns  
Pulse Width, 500 ns  $\pm$ 100 ns (500 ns switches)

#### Logic Levels:

	HIGH	LOW
TTL into 1 k $\Omega$	4V	0V
TTL into 50 $\Omega$	1V	0V
ECL into 50 $\Omega$	0V	-2V

#### Trigger Input

Input impedance 10 k $\Omega$ ; Edge triggered.  
Level: 0.5V or 2V, switch-selected for 1V or 4V systems  
Minimum pulse width: 100 ns  
Polarity: positive or negative slope  
Delay: Rear panel trigger, 0.5  $\mu$ s  $\pm$ 0.5  $\mu$ s  
Front panel trigger, occurs 1  $\mu$ s after pushbutton is released  
Remote trigger, within 1  $\mu$ s after 59308A accepts Trigger Reset Command  
Jitter in pacer mode,  $\pm$ 100 ns after the first cycle

#### Internal Counter

Internal 6-digit counter is incremented each time interval. Total count is output onto the Bus when the 59308A is addressed to Talk. Counter is cleared by Reset Command.

#### Output Format

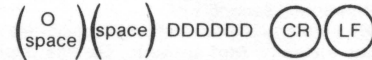

#### Time Base

Crystal frequency: 10 MHz  
Aging Rate: 3 parts in 10<sup>7</sup> per month  
Temperature:  $\pm$ 5 parts in 10<sup>6</sup>, 0° to 50°C

#### Programming Codes

Time in microseconds: [  $\pm$  ] DDD [ E  $\pm$  ] D  
(Note: bracketed entries are optional.)

FUNCTION	ASCII	OCTAL	DECIMAL
Pacer	P	120	80
Timer	T	124	84
Trigger/Reset Command	R	122	82
Enable rear panel trigger	U	125	85
Disable rear panel trigger	A	101	65
Enable Service Request	S	123	83
Disable Service Request	D	104	68

#### Interface Functions and Uses:

Listener	Receives programming codes
Talker	Outputs totalized count or responds to serial poll with status byte
Service Request	If enabled, indicates end of interval
Remote-Local	Switches operation to/from front panel controls and program codes
Device Trigger	Starts time interval and resets counter

Addressing: The programs in this training manual use the address shown. Refer to the label on the 59308A for others.

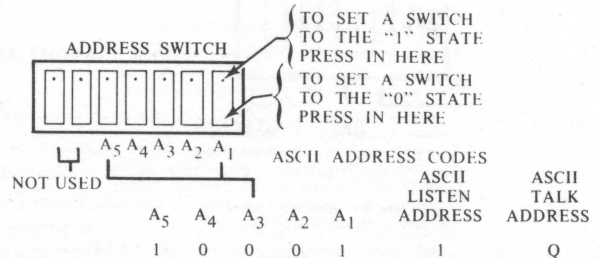

Programming: With the address set as shown, this command keyed into the 9820A/21A sets the 59308A for paced operation with an interval of 3 seconds: CMD "?U1", "003E6PDR".



## 7. SUMMARY-OPERATING THE 59309A DIGITAL CLOCK

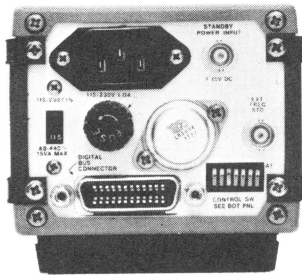

59309A REAR PANEL

### 59309A REAR PANEL

**Control Switch Assembly:** Switches A<sub>1</sub> through A<sub>5</sub> establish the listen address. Switches A<sub>6</sub> and A<sub>7</sub> select mode of operation. Set to "dot out" the clock operates in a controllerless environment and outputs on the Bus at a rate of 40 readings/second. Set to "dot in" the clock is addressable.

**Bus Connector:** 24 pin connector [12151-3283 (Amphenol 57-2-240-2)] mates with cable HP 10631A/B/C.

### 59309A FRONT PANEL, DOOR OPEN

**Calendar:** month, day (Note: Opt. 001 provides Julian Calendar day-of-year digits 001 to 365 or 366).

**Time:** hour, minute, second

**Addressed:** Lights to indicate talking or listening actively.

**Clock Error Indicator (not shown):** Display decimal points all light to indicate possible error because timebase counts have been missed or the power supply has glitched. On the Bus, the status character "?" appears at the beginning of the data string. Error indications remain until clock is reset in any manner.

**Ext/Int:** Selects timebase. Set to Ext, an external precision frequency standard of 1, 5, 10 MHz (1V rms min. into 1 k $\Omega$ ) is accepted.

**Push to Read:** Allows momentary lighting of display when clock is powered by external dc source such as K10-59992. Standby is significantly shortened by this lighting. Inoperative (display can't be lighted) when clock is powered by internal dc standby.

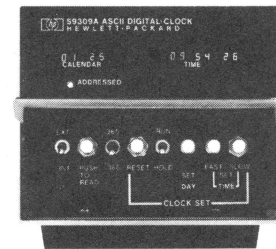

59309A FRONT PANEL, DOOR OPEN

**Standby Power Input:** Accepts input from K10-59992 Standby Power Supply or from any reserve supply capable of providing 8 to 10V dc, 2 mA at 8V (display off).

### GENERAL

#### Clock Set Group

**Reset:** Resets display to 01:01:00:00:00 and starts clock.

**Run/Hold:** 24 hour/day clock advances at 1 sec rate (Run) or stops advancing (Hold).

**Set Day:** Updates day display one count (momentarily depressed) or updates continuously (held in).

**Set Time Fast/Slow:** Updates second and minute displays rapidly (Fast) or slowly (Slow) to permit arriving at desired time.

**Leap Year:** Switch 365 or 366 days/year (non-programmable).

**Timebase:** 1 MHz room temperature crystal; aging rate  $5 \times 10^{-6}$  parts/year. Temperature effects: 10 to 40°C, drift  $5 \times 10^{-6}$  (0.5 sec/day); 0-55°C, drift  $3 \times 10^{-5}$  (3 sec/day).

#### Companion Instrument:

59308A Timing Generator (half-width module) paces/times instruments and provides sub-second to microsecond timing.

**Opt. 001:** Calendar displays and outputs day of year digits, 001 to 365 or 366. Resets to 001:00:00:00.

Addressing: The programs in this manual use the address shown. For others, see the 59309A label.

### FORMAT SWITCH (INSIDE TOP COVER)

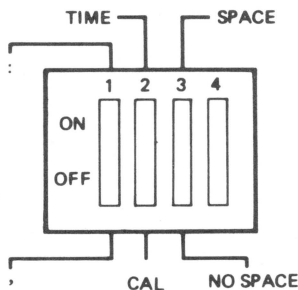

### NOTE

When the 59309A is connected in a system on the interface bus, the front-panel controls are operative.

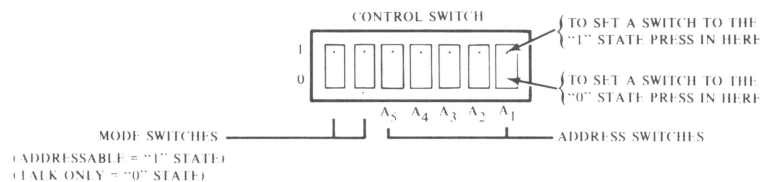

ASCII ADDRESS CODES					ASCII LISTEN ADDRESS	ASCII TALK ADDRESS
A <sub>5</sub>	A <sub>4</sub>	A <sub>3</sub>	A <sub>2</sub>	A <sub>1</sub>		
1	0	0	0	0	Ø	P

### System Operation

When it is addressed to Listen, the 59309A responds to these ASCII codes:

- P Stops the clock
- T Starts the clock
- R Resets the clock to 01:01:00:00:00
- S Updates counting chain 1 second
- M Updates counting chain 1 minute
- H Updates counting chain 1 hour
- D Updates counting chain 1 day
- C Records time command C is accepted and stores time value in output register; value is output when 59309A is addressed to Talk



*DIGITALY REMASTERED*  
*OUT OF PRINT*  
*HEWLETT PACKARD MANUAL SCANS*

By

*Artek Media*

18265 200<sup>th</sup> St.  
Welch, MN 55089

[www.artekmedia.com](http://www.artekmedia.com)

“High resolution scans of obsolete technical manuals”

**ALL HEWLETT PACKARD MANAULS ARE REPRODUCED BY PERMISSION AND UNDER LICENSE AGREEMENT WITH AGILENT TECHNOLOGIES, INC. REMOVAL OF THIS DISCLAIMER IS INVIOATION OF AGILENT TECHNOLOGIES AND ARTEK MEDIA’S COPYRIGHTS. DUPLICATION OR MODIFCATION OF THIS DIGITAL DOCUMENT WITHOUT PRIOR CONSENT IS NOT PERMITTED**

If your looking for a quality scanned technical manual in PDF format please visit our WEB site at [www.artekmedia.com](http://www.artekmedia.com) or drop us an email at [manuals@artekmedia.com](mailto:manuals@artekmedia.com) and we will be happy to email you a current list of the manuals we have available.

If you don't see the manual you need on the list drop us a line anyway we may still be able to point you to other sources. If you have an existing manual you would like scanned please write for details. This can often be done very reasonably in consideration for adding your manual to our library.

Typically the scans in our manuals are done as follows;

- 1) Typed text pages are typically scanned in black and white at 300 dpi.
- 2) Photo pages are typically scanned in gray scale mode at 600 dpi
- 3) Schematic diagram pages are typically scanned in black and white at 600 dpi unless the original manual had colored high lighting (as is the case for some 70's vintage Tektronix manuals).
- 4) Most manuals are text searchable
- 5) All manuals are fully bookmarked

All data is guaranteed for life (yours or mine ... which ever is shorter). If for ANY REASON your file becomes corrupted, deleted or lost, Artek Media will replace the file for the price of shipping, or free via FTP download.

Thanks

Dave & Lynn Henderson  
Artek Media